

Schnitt A-A

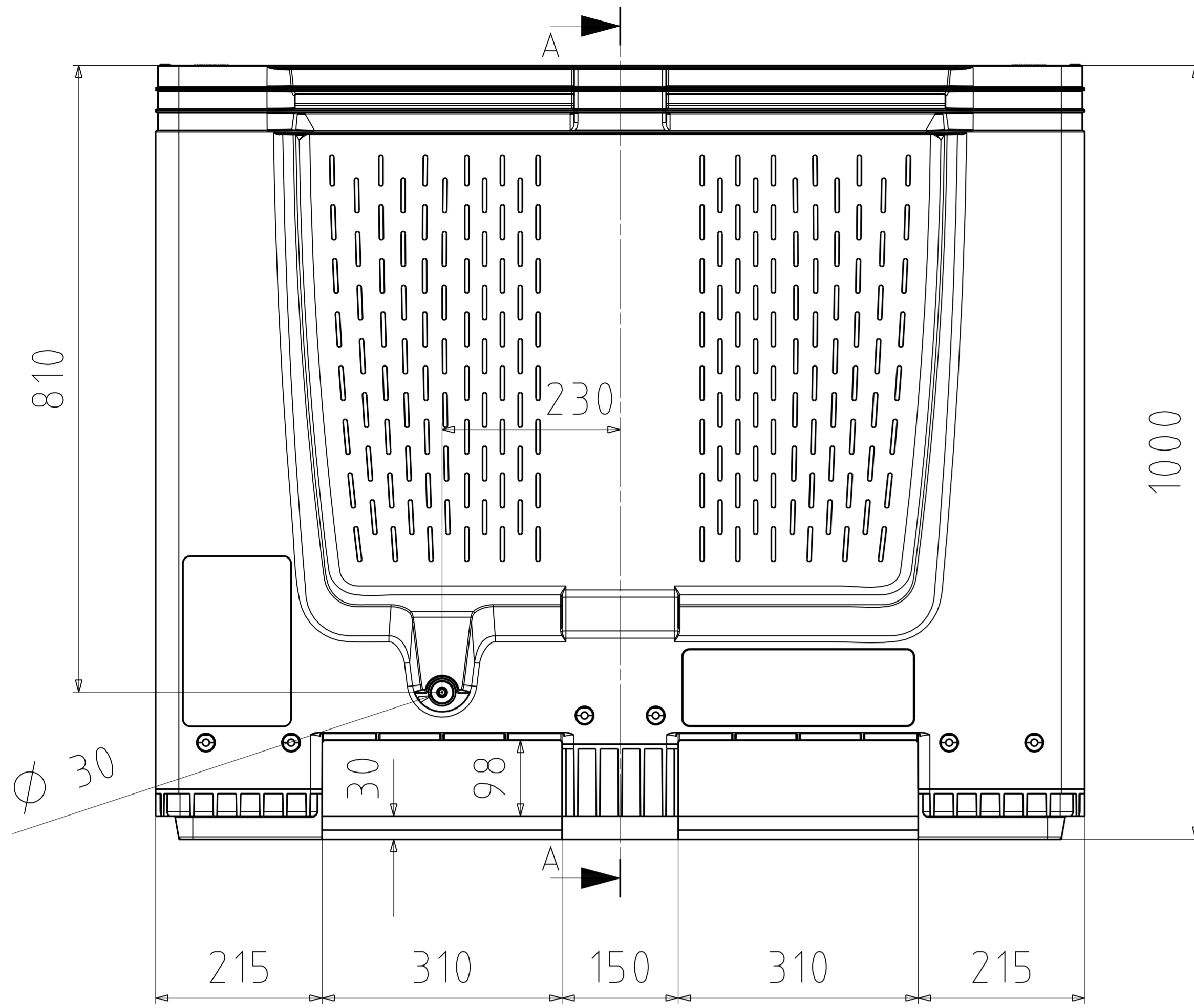

915

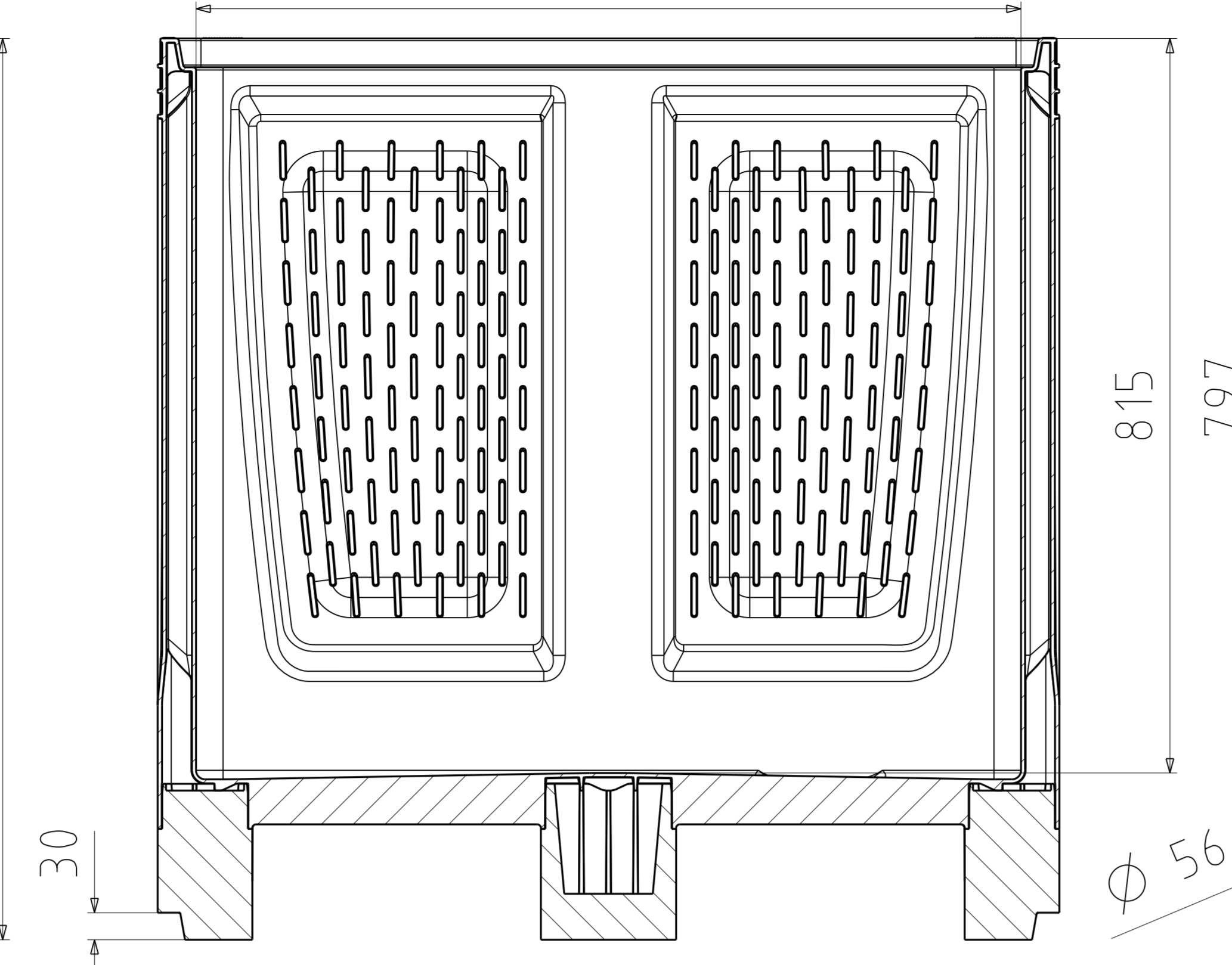

Schnitt B-B

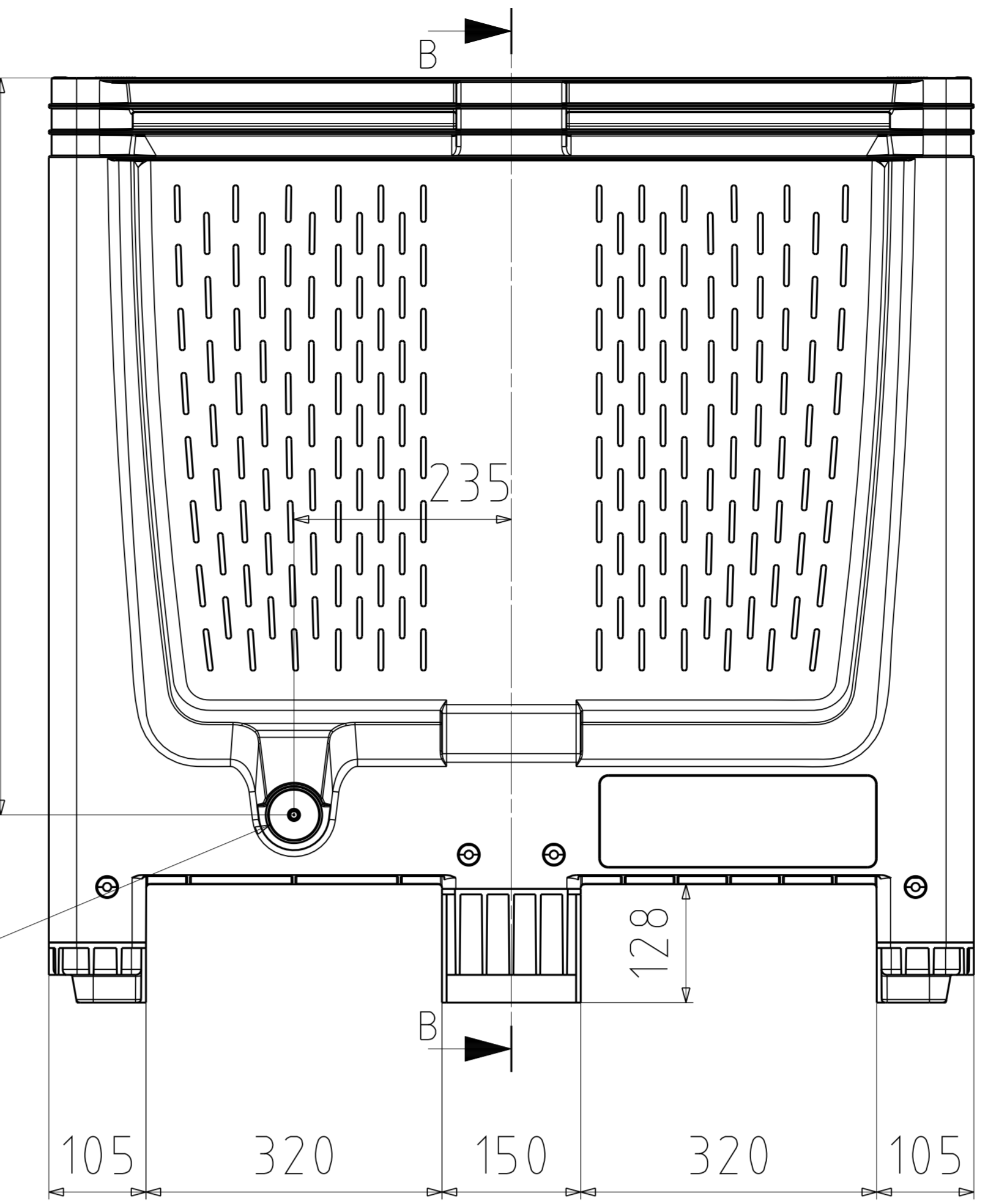

Schnitt B-B

1115

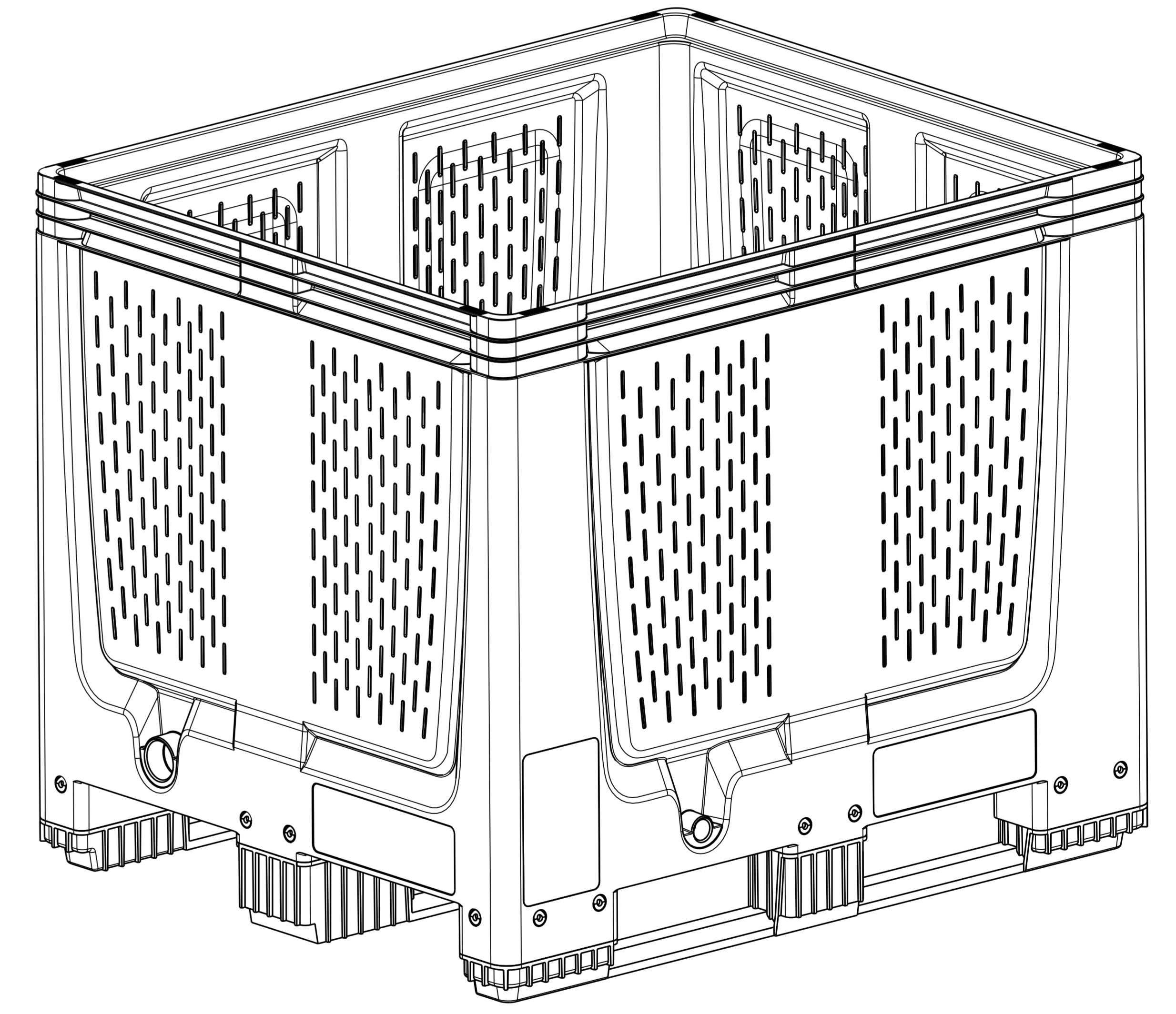
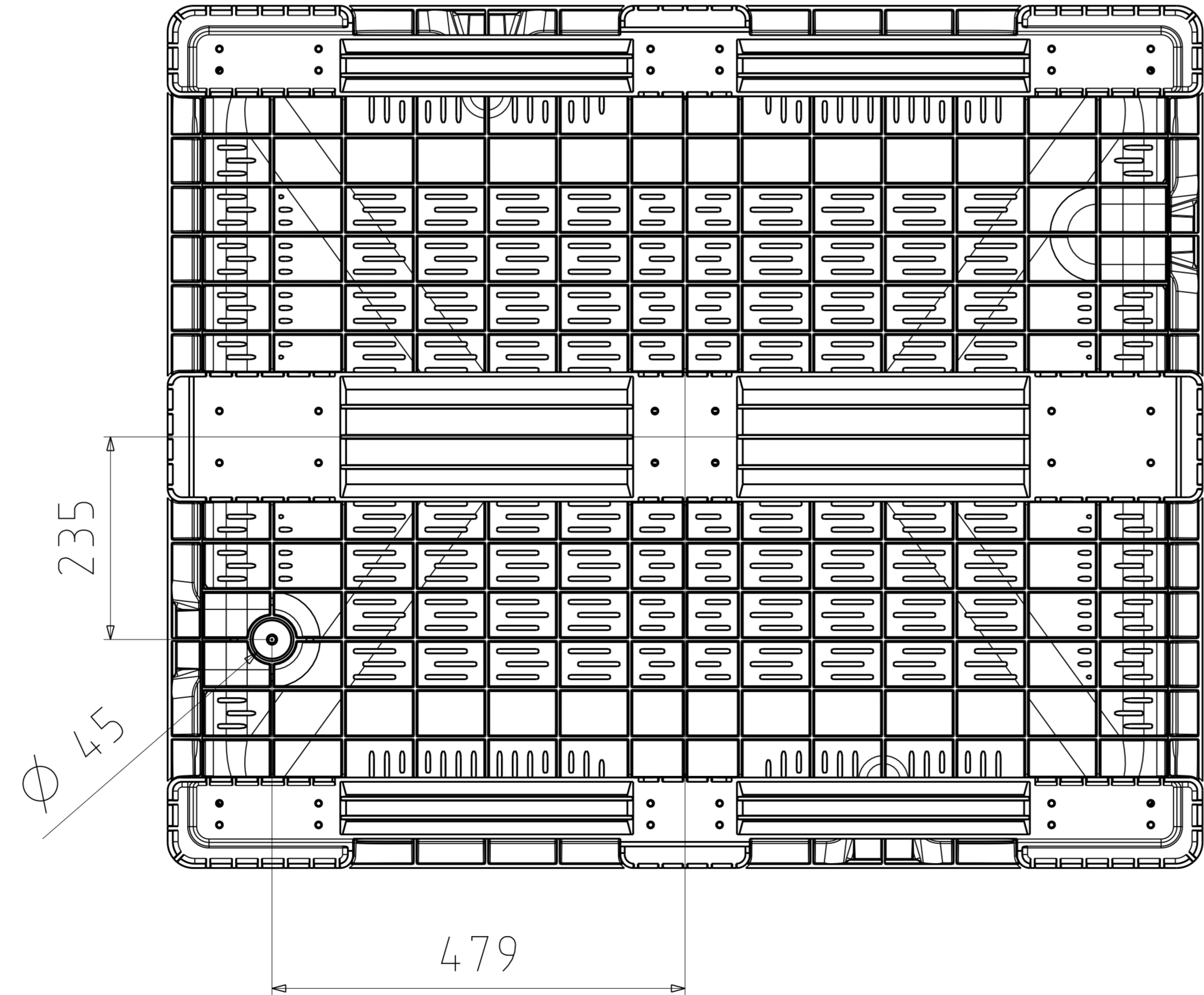
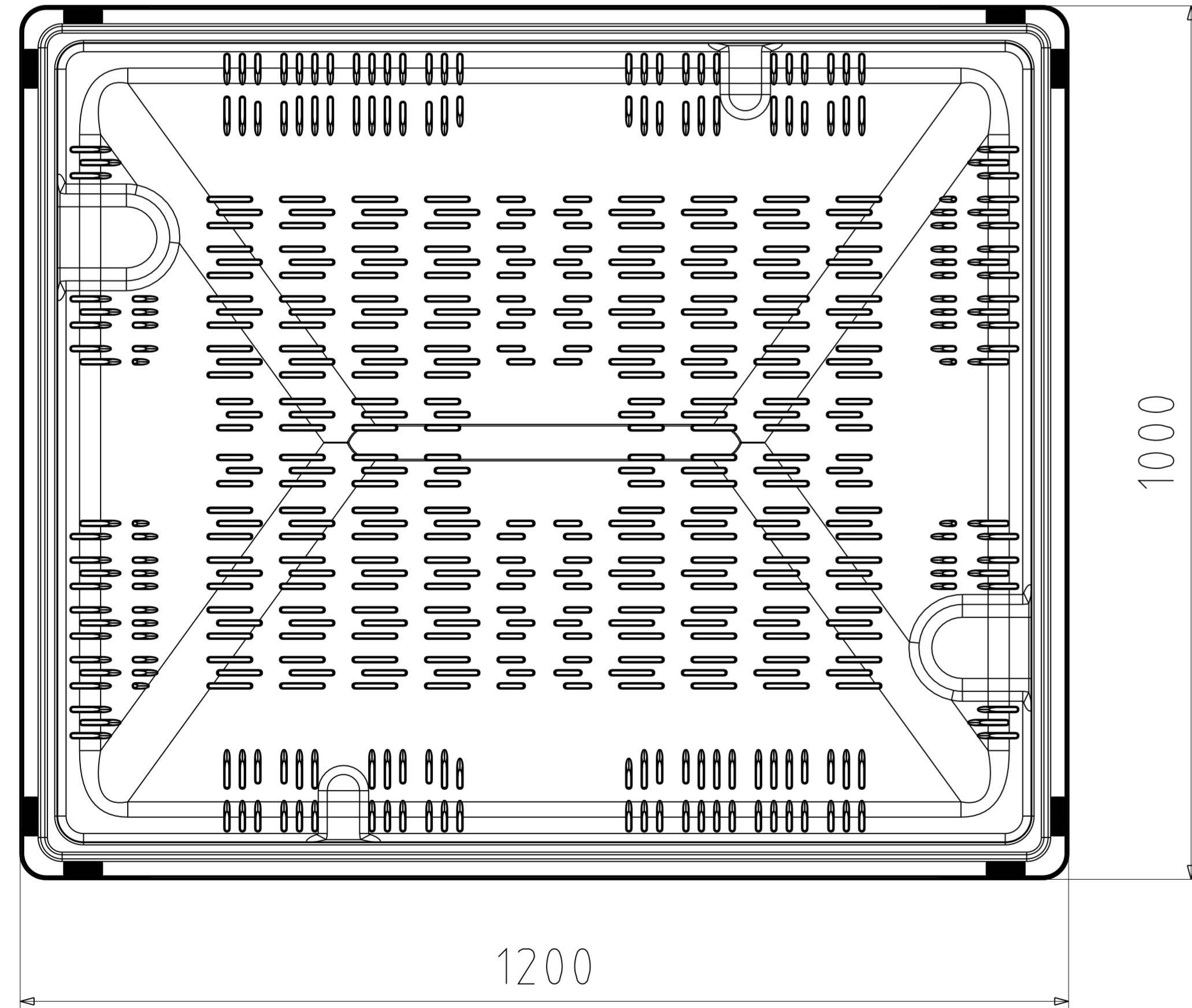
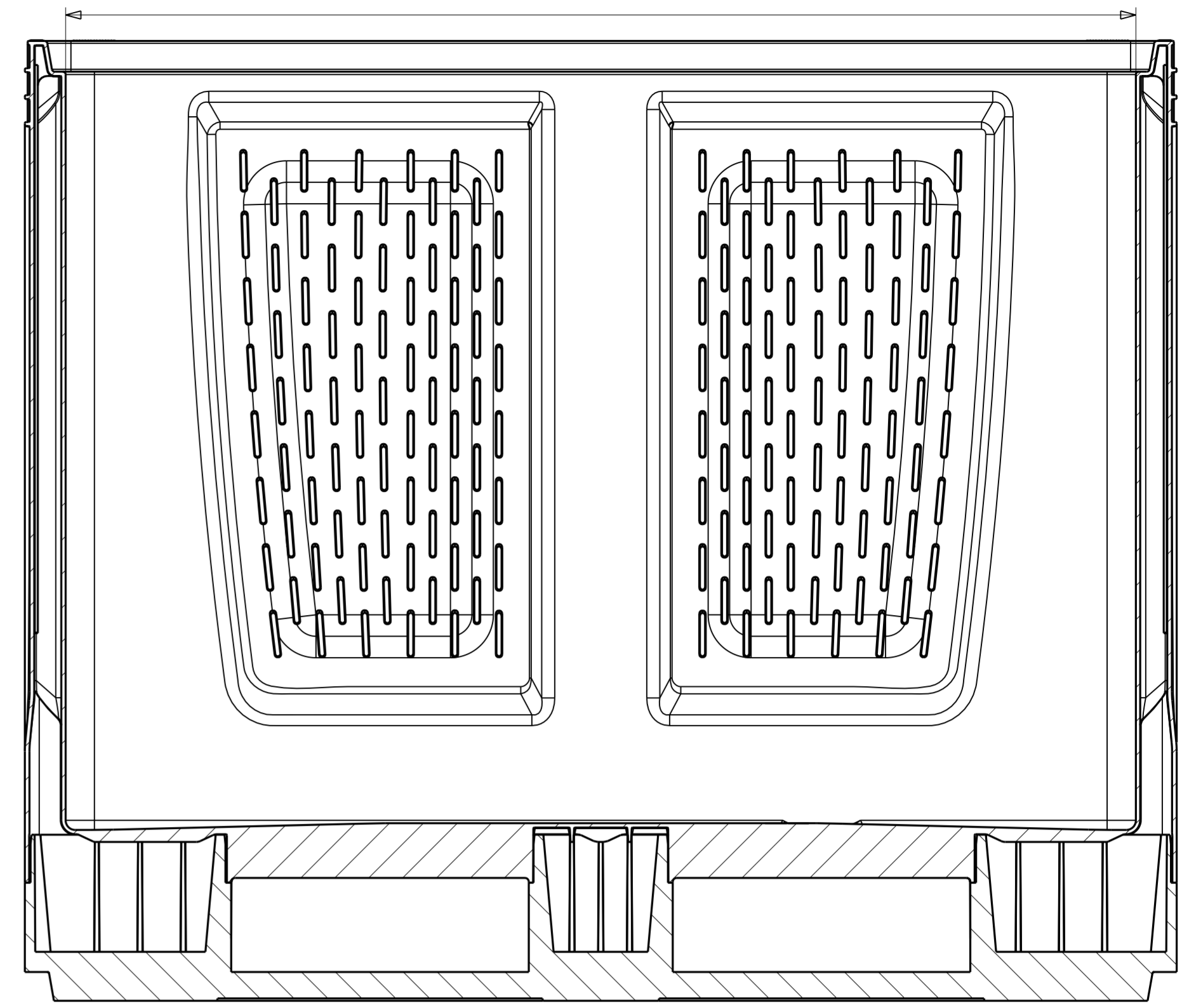

Füllvolumen= 890L

Zust		Änderung		Datum		Name		TeilPos.Nr.		Produkt		Zu Verarb.Mech.		Gewicht	
Mess		Über		Tol.		Tol.		Mess		Gezeichnet		Schuldschir		Zu-08.2011	
30		± 0.1		± 0.05		± 0.05		1:5		Benennung		MBO 1210 K		Auftrags-Nr.	
30.000		± 0.005		± 0.005		± 0.005		1:5		Firma:		Bayer		Bilbner	
Wkgz passend auf:		Wkgz:		Wkgz:		Wkgz:		Wkgz:		Firma:		Bilbner		Größe A	